

Biological relevance of volatile organic compounds emitted during the pathogenic interactions between apple plants and *Erwinia amylovora*

ANTONIO CELLINI¹, GIAMPAOLO BURIANI¹, LORENZO ROCCHI¹, ELENA RONDELLI¹, STEFANO SAVIOLI², MARIA T. RODRIGUEZ ESTRADA², SIMONA M. CRISTESCU³, GUGLIELMO COSTA¹ AND FRANCESCO SPINELLI^{1,*}

¹Department of Agricultural Sciences, Alma Mater Studiorum, University of Bologna, Bologna 40127, Italy

²Department of Agricultural and Food Sciences, Alma Mater Studiorum, University of Bologna, Bologna 40127, Italy

³Department of Molecular and Laser Physics, Radboud University, Institute of Molecules and Materials, Nijmegen 6525AJ, the Netherlands

SUMMARY

Volatile organic compounds emitted during the infection of apple (*Malus pumila* var. *domestica*) plants by *Erwinia amylovora* or *Pseudomonas syringae* pv. *syringae* were studied by gas chromatography-mass spectrometry and proton transfer reaction-mass spectrometry, and used to treat uninfected plants. Infected plants showed a disease-specific emission of volatile organic compounds, including several bio-active compounds, such as hexenal isomers and 2,3-butanediol. Leaf growth promotion and a higher resistance to the pathogen, expressed as a lower bacterial growth and migration in plant tissues, were detected in plants exposed to volatile compounds from *E. amylovora*-infected plants. Transcriptional analysis revealed the activation of salicylic acid synthesis and signal transduction in healthy plants exposed to volatiles produced by *E. amylovora*-infected neighbour plants. In contrast, in the same plants, salicylic acid-dependent responses were repressed after infection, whereas oxylipin metabolism was activated. These results clarify some metabolic and ecological aspects of the pathogenic adaptation of *E. amylovora* to its host.

Keywords: fire blight, growth promotion, microbe-associated molecular patterns, plant resistance, salicylic acid, 2,3-butanediol.

INTRODUCTION

The emission of volatile organic compounds (VOCs) by plants represents a relevant loss of organic carbon, and has been regarded as an adaptive mechanism to cope with stress (Holopainen, 2004; Kesselmeier *et al.*, 2002). The advantages of gaseous functional compounds are associated with their rapid spread throughout and

beyond the individual plant, enabling both a systemic and a population effect.

Many cases of plant responses to pests or pathogens are known to be mediated by VOCs. For instance, specific sets of volatiles are emitted by plants after herbivore feeding as an indirect defence, working as attractors of predators and parasitoids (Arimura *et al.*, 2005; Bruinsma *et al.*, 2009). Several gaseous compounds with a hormonal effect can drive plant growth, phenology and defence responses in the presence of both biotic and abiotic stresses. In particular, the core of plant defence and stress signalling is formed by the interplay between the signalling pathways of ethylene, salicylic acid (SA) and jasmonic acid (JA) and their VOC derivatives (Spinelli *et al.*, 2011c; Verhage *et al.*, 2010). Ethylene emission has been observed in several pathosystems, including apple plants infected by *Erwinia amylovora* (Burrill 1882) (Iakimova *et al.*, 2013; Spinelli *et al.*, 2011a). The volatile methylated forms of SA and JA, which are responsible for long-range (systemic) effects, have also been implicated in numerous plant–pathogen interactions (Champigny and Cameron, 2009; Tamogami *et al.*, 2008). SA is a phenolic compound, which may originate from a phenylalanine ammonia lyase (PAL)- or isochlorogenic acid synthase (ICS)-dependent pathway. Receptors, such as non-expressor of *PR1* (NPR1) and SA binding protein 2 (SABP2), mediate the activation of pathogen-related (*PR*) genes. The oxylipin pathway, initiated by the lipoxygenase (LOX)-dependent oxidation of polyunsaturated fatty acids, ends with the production of several biologically active compounds, including JA and green leaf volatiles (GLVs) (Tamogami *et al.*, 2008; Wasternack and Kombrink, 2010). As JA- and SA-mediated responses are aimed at pathogens with different lifestyles (necrotrophs for JA, biotrophs for SA), their signalling pathways are often mutually antagonistic (An and Mou, 2011). In addition to such conserved signalling pathways, a specific host–pathogen relation may be characterized by a well-defined VOC emission spectrum, with biological effects possibly mediating the pathogen's growth or spread, or the host's response to infection (Cellini *et al.*, 2016; Naznin *et al.*, 2013; Ryu *et al.*, 2004).

*Correspondence: Email: francesco.spinelli3@unibo.it

In this work, the interaction between *E. amylovora* (Ea) and *Malus pumila* var. *domestica* was investigated. Ea is a Gram-negative bacterium with a host range restricted to the Rosaceae family, and is responsible for fire blight disease in pomaceous plants. The main symptoms of this severe disease are twig die-back, caused by the pathogen's multiplication in xylem vessels, and the excretion of bacterial ooze. A comparison has been made with the generalist pathogen *Pseudomonas syringae* pv. *syringae* (Pss), which shares several features with Ea (e.g. both are Gram-negative pathogens, adopting a type III secretion system to deliver effectors into the host cell) and causes similar necrotic symptoms on apple plants (DebRoy *et al.*, 2004).

To provide a biochemical characterization of VOC emissions in apple plants after infection with Ea, gas chromatography-mass spectrometry (GC-MS) and proton transfer reaction-mass spectrometry (PTR-MS) analyses were performed. The latter technique, although not suitable for the precise identification of volatiles, is useful for real-time monitoring of VOC emissions. Subsequently, the existence of biological effects was assessed, with regard to bacterial growth and migration inside the host tissues, and plant growth and metabolism. Finally, the observed biological effects were explained by the analysis of the expression of genes related to the synthesis and signalling of SA and JA.

RESULTS

Dynamics of VOC emissions

In order to obtain a significant description of the volatile compounds emitted by infected plants, a preliminary real-time PTR-MS analysis was run for 96 h post-inoculation to establish whether plants infected with different bacteria could be distinguished according to their VOC emissions, and the time required for such differences to emerge for subsequent GC-MS determination.

During the infection process, the PTR-MS profiles of samples gradually separated according to the pathogen. The transition between the observations at 12 h and 48 h post-inoculation is shown in Fig. 1, demonstrating that, by 48 h post-inoculation, it was possible to discriminate between Ea-infected, Pss-infected and mock-inoculated plantlets. The discrimination was successful at all time points between 48 and 96 h (end of the experiment) post-inoculation.

Characterization of VOCs from infected samples

As PTR-MS profiling of VOCs allowed the discrimination of Ea-infected samples, the compounds responsible for the differences were identified by GC-MS. The analysis was carried out at 3 days post-inoculation, as 48 h were sufficient for recognition by PTR-MS. A list of the VOCs identified by GC-MS analysis is shown in Table 1. Among the compounds characterizing Ea-infected plants, 2,3-butanediol, 3-hydroxy-2-butanone and phenylethyl alcohol

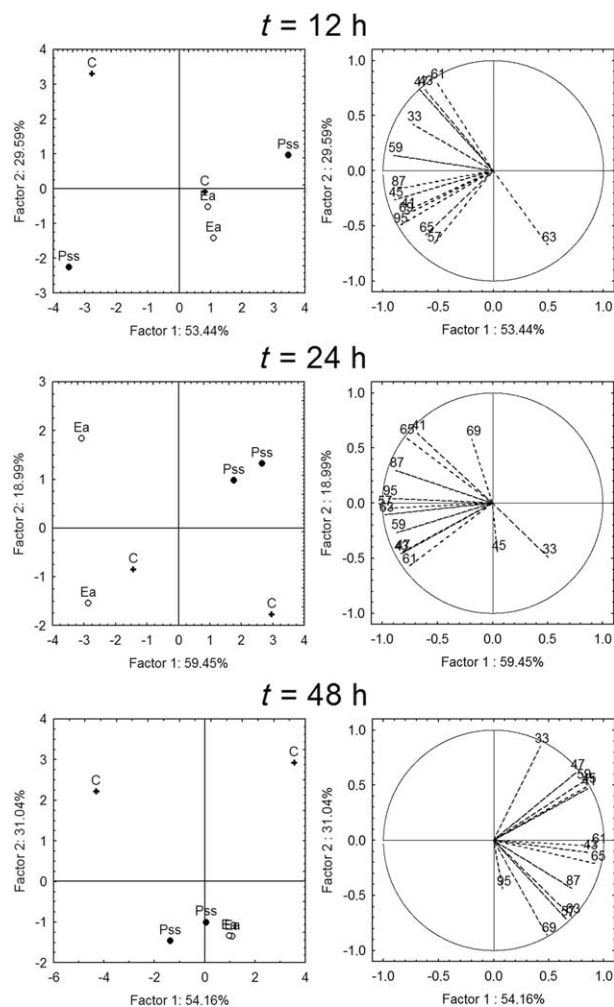

Fig. 1 Principal component analysis of proton transfer reaction-mass spectrometry (PTR-MS) data obtained from *Erwinia amylovora* (Ea)-, *Pseudomonas syringae* pv. *syringae* (Pss)- and mock-infected (C) *in vitro* apple plants, from 12 to 48 h post-inoculation.

were also found in Ea liquid cultures, whereas 3-hexenal, 2-hexenal and 1,2-propanediol production was found only in Ea-infected plants. Some compounds were induced in wounded plants, both infected and mock-inoculated, such as α -farnesene and 3-hexen-1-ol acetate. A subset of the molecules released by Ea-infected plants was selected according to biological relevance and the commercial availability of pure standards, and included 2-hexenal, 3-hydroxy-2-butanone, 2,3-butanediol and phenylethyl alcohol. The concentrations of such compounds were estimated by comparison with standards, and amounted to 6.7 ± 2.6 ng, 8.4 ± 6.9 μ g, 94.6 ± 79.8 μ g and 69.2 ± 23.6 ng/g fresh weight, respectively.

PTR-MS data, obtained from the same sample set, supported the GC-MS results. Indeed, infection with Ea resulted in an increase in *m/z* fragments 81 and 87, which can be ascribed to

Table 1 Gas chromatography-mass spectrometry (GC-MS) identification and relative quantification of volatile organic compounds (VOCs) emitted by *in vitro* apple plants and *Ea* cultures grown in Luria–Bertani (LB) broth (provided as percentage of total emission).

Compound	LRI	Ea liquid culture	Plant samples			
			Ea-infected	Pss-infected	Mock-infected	Healthy
2-Ethoxy-2-methyl-propane	672		11.3 ± 2.1	5.4 ± 0.9	4.9 ± 2.2	11.7 ± 1.0
2,4,4-Trimethyl-1-pentene	739		18.8 ± 3.7	12.1 ± 2.1	9.8 ± 1.4	13.8 ± 1.7
Branched alkane, C8–9	777	0.8 ± 0.4	2.8 ± 0.7	2.6 ± 0.6	2.8 ± 1.1	4.0 ± 0.7
Branched alkane, C8–9	820		3.5 ± 0.5	5.0 ± 1.1	4.7 ± 1.7	5.4 ± 0.6
Branched alkane, C8–9	868		0.5 ± 0.4	1.1 ± 0.6	0.8 ± 0.4	0.7 ± 0.3
2,4-Dimethyl-1-heptene	894	1.7 ± 1.0	2.6 ± 0.5	9.7 ± 3.5	17.9 ± 3.9	7.6 ± 2.0
3-Methyl-butanol	917	0.6 ± 0.6				
Ethanol	929	14.7 ± 13.2	0.4 ± 0.1	0.4 ± 0.1	0.4 ± 0.2	0.3 ± 0.3
Branched alkane, C8–10	965		1.3 ± 0.1	1.4 ± 0.2	0.8 ± 0.4	0.9 ± 0.2
2,3-Butanedione	977	1.4 ± 0.4				
Branched alkane, C > 9	1008		2.8 ± 0.6	6.1 ± 2.2	11.1 ± 4.0	2.8 ± 0.9
Branched alkane, C > 9	1031		0.1 ± 0.1	1.2 ± 0.6	1.2 ± 0.8	0.7 ± 0.3
Branched alkane, C > 9	1035		0.9 ± 0.4	3.3 ± 2.2	10.3 ± 3.6	2.9 ± 1.3
Branched alkane, C > 9	1066		0.2 ± 0.1	2.6 ± 1.4	1.0 ± 0.5	0.8 ± 0.4
2-Methyl-1-propanol	1100	4.9 ± 4.0	1.9 ± 0.2	1.8 ± 0.5	0.5 ± 0.3	0.9 ± 0.2
(<i>E</i>)–3-Hexenal	1143		2.8 ± 2.2	0.3 ± 0.2		0.2 ± 0.1
1-Undecene	1153			11.2 ± 7.6		
(<i>E</i>)–2-Hexenal	1207		4.2 ± 2.2	0.9 ± 0.8	0.9 ± 0.7	0.6 ± 0.4
3-Methyl-1-butanol	1212	54.7 ± 14.2				
Branched alkane, C10–11	1266		1.3 ± 0.4	2.2 ± 0.5	3.6 ± 1.0	2.1 ± 0.3
3-Hydroxy-2-butanone	1270	16.0 ± 4.4	4.3 ± 3.2	0.2 ± 0.1		
Alkene, C > 11	1305		4.5 ± 0.6	3.9 ± 0.9	2.8 ± 1.0	5.9 ± 0.9
(<i>Z</i>)–3-Hexen-1-ol, acetate	1315		1.4 ± 0.6	2.4 ± 0.9	2.2 ± 0.6	
Propanoic acid, anhydride	1330		1.7 ± 0.3	1.6 ± 0.3	1.2 ± 0.4	2.6 ± 0.5
Alkene, C > 11	1332		4.7 ± 0.8	4.5 ± 0.9	3.6 ± 1.0	5.9 ± 0.9
(<i>Z</i>)–3-Hexen-1-ol	1379		1.4 ± 1.1	2.2 ± 1.3	1.8 ± 0.8	1.6 ± 0.4
Branched ketone, C > 10	1414		0.8 ± 0.3	1.5 ± 0.5	1.7 ± 0.6	4.0 ± 0.8
Branched ketone, C > 10	1459		1.0 ± 0.3	2.1 ± 0.8	3.0 ± 1.1	3.2 ± 1.0
2,3-Butanediol	1527	0.2 ± 0.2	3.2 ± 2.7			0.2 ± 0.1
1,2-Propanediol	1565		0.7 ± 0.5			
Ketone or aldehyde, C > 9	1585		1.2 ± 0.2	0.8 ± 0.1	0.9 ± 0.1	1.0 ± 0.2
α-Farnesene	1751		2.8 ± 1.6	4.6 ± 3.0	3.1 ± 2.3	
Phenylethyl alcohol	1893	1.7 ± 0.8	1.6 ± 0.7			

Linear retention index (LRI) is provided for each compound. Values (average ± standard error of the mean) were calculated from three samples, each consisting of four plantlets enclosed in a 150-mL jar or 50-mL glass tubes containing 10 mL of LB medium (for bacterial cultures). *Ea*, *Erwinia amylovora*; *Pss*, *Pseudomonas syringae* pv. *syringae*.

hexenal isomers and 2,3-butanedione, respectively (Fig. 2). In addition, other *m/z* fragments may originate from relevant compounds: fragment 63 from dimethyl sulfide, fragment 69 from isoprene, hexenol, 3-methyl-butanol or other alcohols/aldehydes, and fragment 83 from hexenal.

Effects of pre-exposure to infected plants on endophytic pathogen growth and migration

An experiment was set up with *in vitro* healthy plants, pre-exposed to VOCs from infected plants included in the same pot, but avoiding any direct contact (Fig. 3a). The susceptibility of such pre-exposed plants was determined by the quantification of the endophytic population of *Ea* at 3 days post-inoculation. In a series of independent experiments, the population of *Ea* in pre-exposed

acceptor *in vitro* plantlets was decreased by one to three orders of magnitude. Conversely, in similar experiments performed with *Pss*, no significant differences emerged in the population size of this pathogen (Figs 4 and S1, see Supporting Information). To confirm the effect of VOCs released during infection with *Ea* in more natural conditions, experiments were repeated on potted seedlings, included in air-proof bags and maintained under a continuous flow of VOCs from infected plants (Fig. 3b). The effects on the pathogen population at 7 days post-inoculation were comparable with those obtained in *in vitro* plantlets pre-exposed to infected neighbours. However, the decrease in the endophytic *Ea* population was less pronounced than in plants exposed to a static accumulation of VOCs produced by infected neighbour plants (Fig. 4). Finally, the *Ea* migration rate in infected seedlings was halved by pre-exposure to diseased plants (Fig. 5).

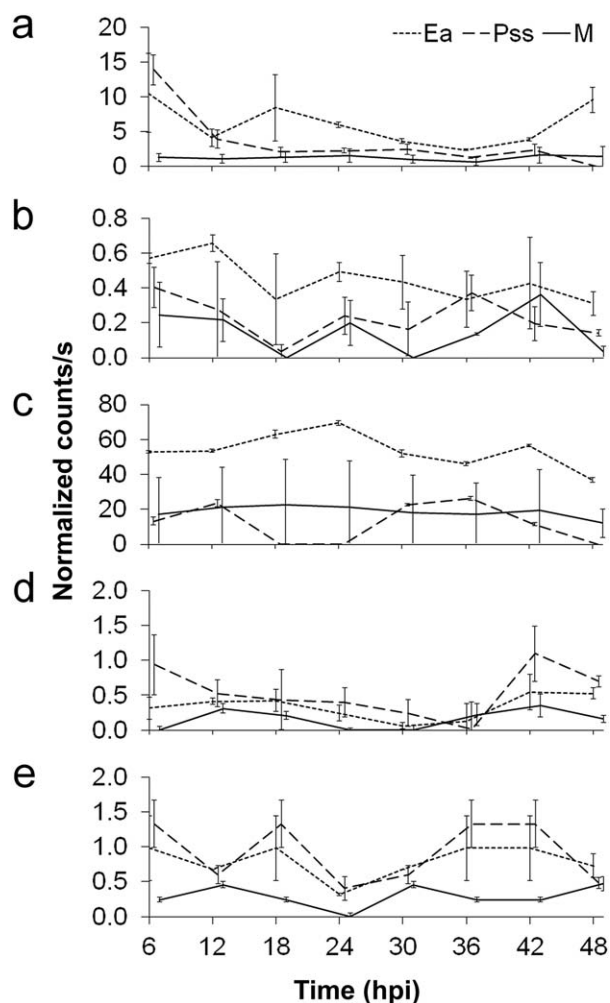

Fig. 2 Real-time emission of relevant m/z fragments, measured by proton transfer reaction-mass spectrometry (PTR-MS) on *Erwinia amylovora* (Ea)-, *Pseudomonas syringae* pv. *syringae* (Pss)- and mock-infected (M) *in vitro* apple plants. The m/z fragments were tentatively identified as: (a) 81: hexenal isomers or monoterpenes; (b) 87: 2,3-butanedione; (c) 63: dimethyl sulfide; (d) 69: isoprene, hexenol, 3-methyl-butanal or other alcohols/aldehydes; (e) 83: hexanal. The standard error is shown for each data point. hpi, hours post-inoculation.

Effects of pre-exposure to infected plants on plant growth and metabolism

To verify whether VOCs emitted during infection influence the growth and metabolism of healthy neighbouring plants, *in vitro* plantlets were exposed to infected plants for 21 days. After this period, no significant differences were found in daily carbon fixation or dry weight fresh weight ratio on exposure to either Ea- or Pss-infected VOC emitters (Fig. 6a,b). Instead, VOCs from Ea-infected plants induced an increase in total leaf area in healthy receiver plants (Fig. 6c).

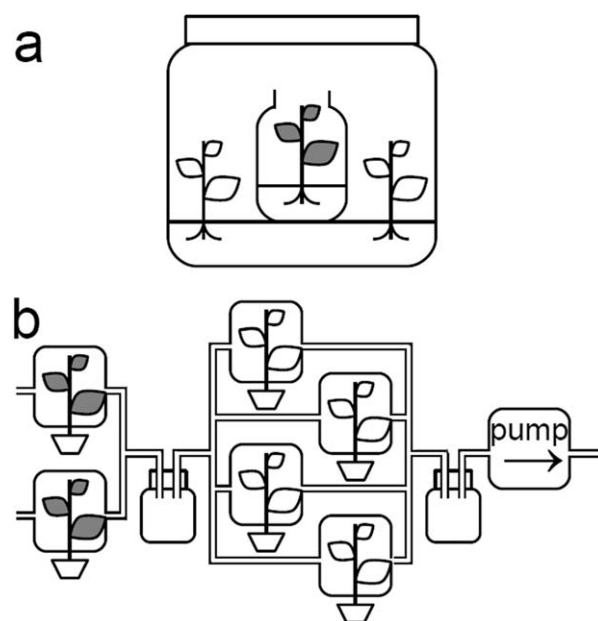

Fig. 3 Schematic representation of the experimental set-up designed for the investigation of volatile organic compound (VOC)-mediated inter-plant communication. (a) Static accumulation experiments. *In vitro*-cultivated receiver plantlets (in white) were placed in a 1.5-L jar, including infected plants (VOC emitters, in grey) placed in a 150-mL vial, to prevent physical contact and bacterial movement. After a 7-day exposure, emitting plants were removed and receiving plants were inoculated or used for subsequent experiments. (b) Dynamic flow experiments. Potted apple plants were enclosed in odourless plastic bags and connected by silicon tubes under an air flow of 9 L/min, generated by a vacuum pump. The VOCs collected from infected (emitter) plants (in grey) were mixed in a buffer jar and flowed onto receiver plants (in white) for 7 days. After this time, receiver plants were inoculated for subsequent analysis.

SA- and JA-related gene expression

As the pre-exposure to Ea-infected plants reduces both pathogen growth and migration, an induction of plant defences was hypothesized. Thus, the expression of several genes, involved in plant defences, was investigated in relation to pre-exposure to Ea-infected plants, and subsequent infection with the same pathogen. The expression of *PAL* was not detectable in any condition. The exposure to VOCs from infected plants induced the expression of *ICS*, the SA signal transduction components *SABP2* and *NPR1*, and *PR1*, *PR5* and *PR8* in healthy neighbour plants. However, the subsequent infection substantially reduced the expression of these genes. No significant expression was found in non-exposed plants, either infected or not infected. With regard to *LOX1A* and *LOX2A*, a higher induction took place in exposed, infected plants compared with exposed, non-infected plants. A faint expression was also found in non-exposed, infected samples (Fig. 7).

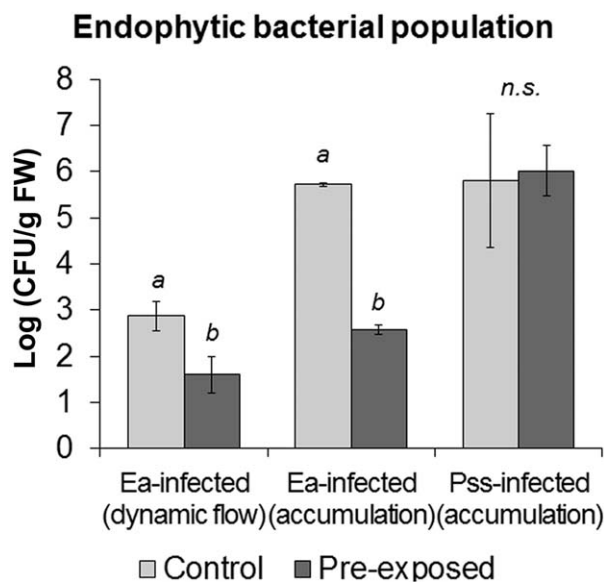

Fig. 4 Endophytic bacterial population in apple plants at 7 days (for dynamic flow experiments) or 3 days (for static accumulation experiments) post-inoculation with *Erwinia amylovora* (Ea) or *Pseudomonas syringae* pv. *syringae* (Pss), after previous exposure to plants infected with the same bacterium. Control represents plants exposed to mock-infected neighbours. Mean and standard error were calculated for \log_{10} (CFU/g fresh tissue weight). Different letters indicate significant differences ($P \leq 0.05$) between treated (pre-exposed) and control (non-pre-exposed) samples in the same experimental set, according to Student's *t*-test; non-significant differences are indicated by *n.s.* CFU, colony-forming unit; FW, fresh weight.

DISCUSSION

VOC emission and bacterial growth

In this work, a specific VOC emission was shown for Ea-infected apple plants. Some compounds, such as 2,3-butanediol, 3-hydroxy-2-butanone and phenylethyl alcohol, were produced by the bacterium even in artificial growth medium, independently from plant-derived metabolites, whereas others (hexenal isomers, 1,2-propanediol) were induced in plants after infection with Ea.

The emission of biologically active gases by Ea-infected plants has been recorded previously. For instance, ethylene levels have been observed to increase after Ea infection (Iakimova *et al.*, 2013; Spinelli *et al.*, 2011a). The emission of isoprene and terpenoids by Ea in pure culture and in Ea-infected pear plants has also been recorded (Spinelli *et al.*, 2012). Isoprene and terpenoids are well-known modulators of the plant-pathogenic response (Gershenson and Dudareva, 2007). Moreover, they may generate ozone and other reactive oxygen species in the presence of UV radiation (Sharkey *et al.*, 2008), thus mediating direct toxicity against pathogens or plant stress responses (Spinelli *et al.*, 2011a).

This work presents other compounds specifically emitted by Ea or Ea-infected plants which may affect plant growth or defence.

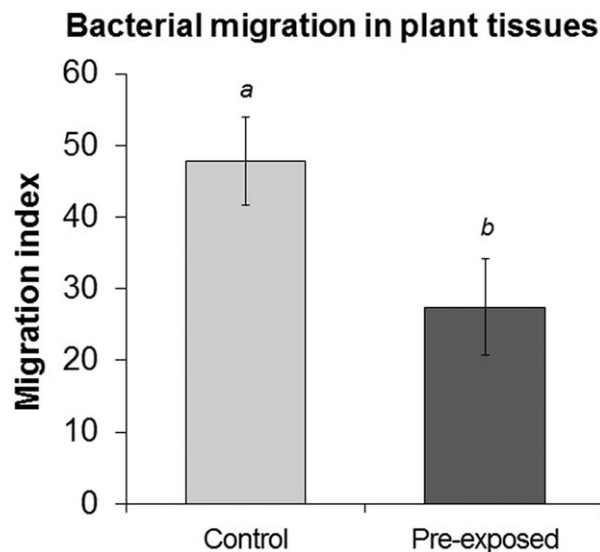

Fig. 5 Migration of *Erwinia amylovora* (strain 1/79-GFP) in tissues of experimentally inoculated potted apple plants, pre-exposed to an air flow from infected volatile organic compound (VOC) emitters, at 7 days post-inoculation. The index is calculated as the ratio of infected veins multiplied by the mean value of the relative length of migration inside the veins. Values are presented as mean \pm standard error. Differences between pre-exposed and control samples are significant at $P \leq 0.05$, according to Student's *t*-test.

Hexenal isomers belong to the GLV subgroup of the oxylipin family. Their effects on pathogen viability, insect behaviour and induction of the defence response in plants have been reported previously (reviewed by Matsui, 2006). Phenylethyl alcohol can be produced by both plants and microorganisms (Kai *et al.*, 2007; Spinelli *et al.*, 2012), and may have antimicrobial effects, by altering membrane permeability and nutrient transport in cells, thus playing an ecological role in the competition of Ea against other microbes in the phyllosphere. The production of 1,2-propanediol is probably caused by the anaerobic fermentation of sugars (Saxena *et al.*, 2010), but no biological effects of this compound are known.

2,3-Butanediol and related compounds, such as acetoin (3-hydroxy-2-butanone) and 2,3-butanedione, are produced directly by bacteria (Spinelli *et al.*, 2012), and induce resistance in *Arabidopsis* (Ryu *et al.*, 2004) against *Pectobacterium carotovorum* (formerly *Erwinia carotovora*) and in pear against Ea (Spinelli *et al.*, 2012). However, the same bacterium requires the 2,3-butanediol biosynthetic pathway to induce pathogenesis (Marquez-Villavicencio *et al.*, 2011), as a source of NAD^+ in fermentative metabolism. Finally, the induced resistance stimulated by 2,3-butanediol is effective on some, but not all, pathogen species (Han *et al.*, 2006).

Overall, plant-emitted VOCs and bacterial metabolism by-products may affect both the host and the pathogen (Fig. 8). Considering their effects as growth and defence promoters,

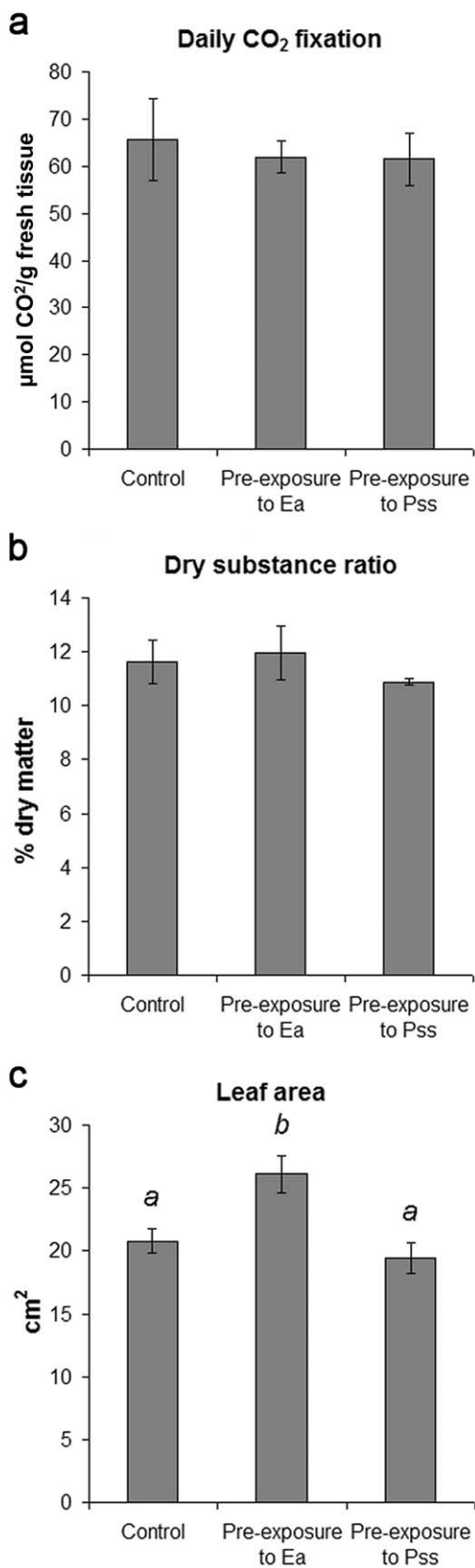

Fig. 6 Biometric and physiological parameters of healthy micropropagated apple plants after 21 days of exposure to *Erwinia amylovora* (Ea)- or *Pseudomonas syringae* pv. *syringae* (Pss)-infected plants: (a) daily CO₂ fixation, normalized to fresh sample weight; (b) percentage of dry matter over total fresh tissue; (c) total leaf area. Data are presented as the mean \pm standard error of values obtained from four samples, each consisting of eight plantlets included in the same jar. Different lower-case letters indicate the significance of the differences ($P \leq 0.05$) between pre-exposed and control samples, according to Student's *t*-test.

biologically active VOCs may be regarded as a special type of microbe-associated molecular pattern.

VOC-induced changes in plant growth

As hormonal effects have been reported previously for some of the VOCs emitted during the host–pathogen interaction, the induction of changes indicating different growth patterns in healthy plants exposed to diseased plants was investigated. Total leaf area, but not total carbon fixation, was increased in Ea-exposed plants. Therefore, tissue differentiation, rather than plant growth, may be influenced by VOCs. Plant growth promotion by 2,3-butanediol-producing bacteria has been recorded previously in micropropagated apple plants (Spinelli *et al.*, 2011b), and was ascribed to a cytokinin-dependent mechanism (Ryu *et al.*, 2003). A plant growth-promoting fungus, *Phoma* sp. GS8-3, which stimulates the growth of tobacco seedlings, shares several VOCs with Ea, including 3-hydroxy-2-butanone and phenylethyl alcohol (Naznin *et al.*, 2013), but none of the components of the VOC blend was uniquely responsible for the growth-promoting effect.

Induction of defensive responses

Unlike Pss, which is not significantly affected, Ea growth and migration are reduced in plants previously exposed to VOCs emitted by infected plants (Figs 4 and 5), even in the dynamic flow experimental setting, suggesting the biological relevance of VOCs, even at low concentrations in natural conditions. Ea VOC-mediated self-inhibition of growth was ruled out in previous work (Spinelli *et al.*, 2012).

The induction of plant resistance by 2,3-butanediol in *Arabidopsis* was found to be connected with the ethylene–JA signal cascade, but not SA synthesis or NPR1 (Ryu *et al.*, 2004). In contrast, in this work, gene expression analysis showed that pre-exposure greatly enhances SA production and signalling (including NPR1), whereas infection leads to the partial suppression of this response.

Overall, a model can be suggested in which the host plant employs Ea-derived metabolites to trigger both JA- and SA-related responses. However, the pathogen inhibits SA-dependent, but not JA-dependent, responses. As a result, PR genes and other defence responses may be activated in the presence of pathogen-derived

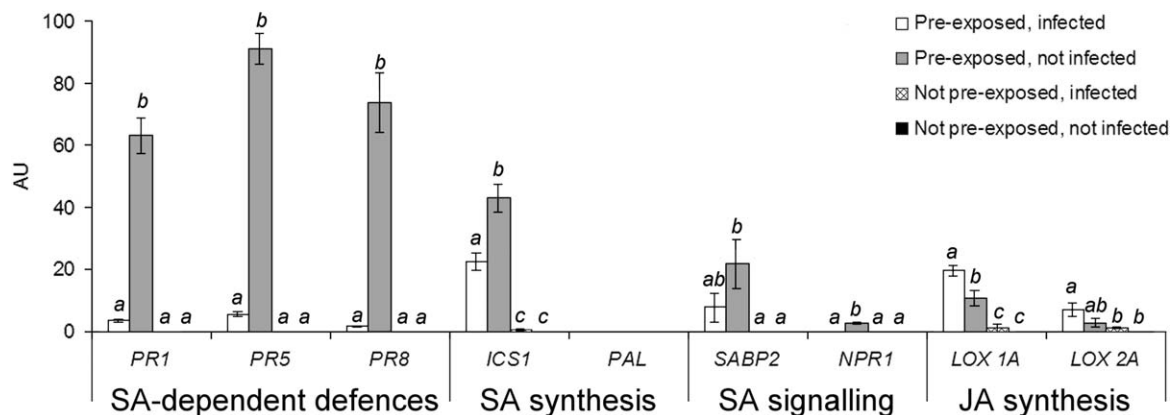

Fig. 7 Expression analysis of genes in *in vitro* apple plants, maintained on half-concentration Murashige and Skoog (MS) agarized medium, according to their pre-exposure (7 days) to *Erwinia amylovora*-infected plants and subsequent infection with the same pathogen. Samples were harvested at 3 days post-inoculation. Data are expressed in arbitrary units (AU) relative to actin expression after a $\Delta\Delta Ct$ -based analysis. For each gene, different letters indicate statistically significant differences according to Student–Newman–Keuls’ test ($P \leq 0.05$).

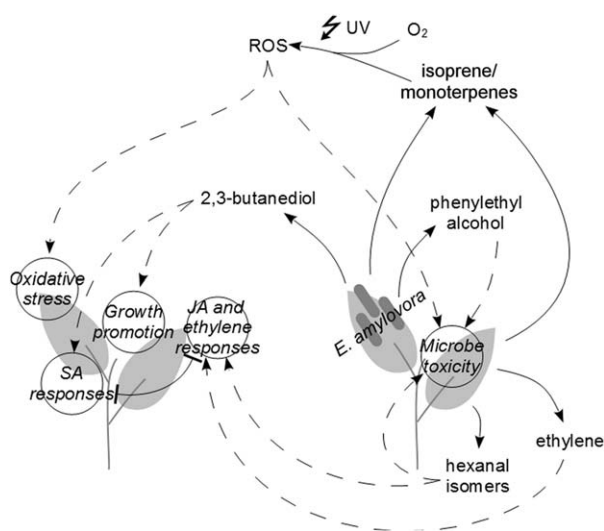

Fig. 8 Model of the interactions between *Erwinia amylovora*-infected and neighbouring apple plants mediated by volatile organic compounds (VOCs). Solid arrows indicate the identified VOCs, broken arrows indicate their effects, and blunt ends indicate antagonism. Hexenal isomers (this work) and ethylene (Iakimova *et al.*, 2013; Spinelli *et al.*, 2011a) originate from infected plants, and activate jasmonic acid (JA)- and ethylene-dependent responses; furthermore, green leaf volatiles, such as hexenal, have a toxic effect on the pathogen (Matsui, 2006). Phenylethyl alcohol and 2,3-butanediol are produced by bacterial metabolism: the former may aid the pathogen in microbial competition (Kai *et al.*, 2007), whereas the latter is perceived by plants and induces growth promotion (Ryu *et al.*, 2003) and salicylic acid (SA)-mediated plant defences. Both the host plant and the pathogen may contribute to isoprene and terpenoid emission (Spinelli *et al.*, 2012). The oxidative stress, resulting from the reaction of such compounds with oxygen and UV radiation, possibly aids plant defences, either by the toxic effect of ozone and other reactive oxygen species (ROS), or by the indirect mediation of plant signal transduction.

cues (Bonasera *et al.*, 2006; Sarowar *et al.*, 2011), and partially or completely repressed by the invading pathogen. Our experiments do not allow us to establish whether *Ea* manipulates LOX-mediated JA biosynthesis directly to suppress SA signalling, or whether the induction of LOX is the secondary outcome of the disruption of the plant hormonal balance, mediated by pathogenesis effector proteins or ethylene. Indeed, the latter has been reported previously (Iakimova *et al.*, 2013) to contribute to *Ea* pathogenicity, rather than to the elicitation of plant defences. Remarkably, the recognition of a volatile signal by host plants potentially triggers a remote and systemic pre-alert status, whereas the pathogen requires the physical interaction with host cells to stop the defence response. Only a faint induction of *LOX* and *ICS1* genes could be detected in non-VOC-treated, infected plants, compared with pre-exposed plants. This may be explained by their shorter exposure to defence-inducing compounds compared with pre-exposed plants (i.e. 3 days from inoculation to sampling vs. 7 days pre-exposure plus 3 days post-inoculation).

There is evidence for the role of SA and JA in the protection of pomaceous plants against *Ea*. Both molecular data (DebRoy *et al.*, 2004) and field application of SA and its functional analogue benzothiadiazole (Sparla *et al.*, 2004; Spinelli *et al.*, 2006) support the involvement of SA in the improvement of the plant’s resistance to the pathogen. However, JA depletion after *Ea* infection was found in highly susceptible, but not tolerant, apple genotypes (de Bernonville *et al.*, 2012). As *Ea* infection does not repress *LOX* genes, these may provide a molecular basis for tolerance responses mediated by JA and oxylipins.

CONCLUSIONS

In this work, *Ea*-derived VOCs have been shown to stimulate defences in apple plant hosts. Such effects are detectable in both *in vitro* and real-scale conditions. In spite of clues with regard to

the biochemical composition of biologically active volatile emissions, and the activation of specific plant defences, open questions remain on how such compounds are perceived by the plant, and how plant responses are suppressed by Ea. In this perspective, new protection strategies based on volatile plant resistance inducers may be developed for field application.

EXPERIMENTAL PROCEDURES

Biological material and inoculation

The experiments were performed on either *in vitro*-rooted apple (cv. Golden Delicious) plantlets (c. 3 cm) or 6-month-old seedlings obtained from apple cv. Golden Delicious. *In vitro* plants were micropropagated in agarized medium [Murashige and Skoog (MS); Murashige and Skoog, 1962) containing sucrose (30 g/L), myo-inositol (100 mg/L), thiamine-HCl (1 mg/L), nicotinic acid (1 mg/L), pyridoxine (1 mg/L), glycine (1 mg/L), indolebutyric acid (0.05 mg/L), benzylaminopurine (1 mg/L) and gibberellic acid 3 (0.1 mg/L), adjusted to pH 5.7 with KOH. The explants were subsequently rooted in half-concentration MS medium containing sucrose (20 g/L), myo-inositol (100 mg/L), thiamine-HCl (1 mg/L), nicotinic acid (1 mg/L), pyridoxine (1 mg/L), glycine (1 mg/L) and indolebutyric acid (0.1 mg/L), pH 5.7. Before the experiments, the plants were transferred to minimal medium containing only half-concentration MS inorganic salts, adjusted to pH 5.7. The plants were kept in a growth chamber at 22 ± 2 °C, with a 16-h 8-h light dark period and illumination at $50 \mu\text{E}/\text{m}^2/\text{s}$.

With regard to Golden Delicious seedlings, plants were kept in glasshouse conditions (26 °C, 40% relative humidity) under natural light in 1-L pots on a substrate obtained by mixing 1 : 1 (v v) peat and sand. The peat mineral concentration declared by the manufacturer was as follows: NH_4^+ , 25 g/m³; NO_3^- , 35 g/m³; P_2O_5 , 104 g/m³; K_2O , 120 g/m³; MgO, 12 g/m³; micronutrients, 25 g/m³. Standard irrigation and fertilization were applied. As the mineral fertilizer, 6 g per plant of Poly-Feed (16N-8P-32K; Fertica S.A., HAIFA Chemicals Ltd., Haifa, Israel) were applied at leaf expansion and 3 weeks later.

The bacterial strains used were Ea ICMP 1540 (holotype), ICMP 1540-GFP and 1 79-GFP, transgenic strains encoding a fluorescent marker protein (Spinelli *et al.*, 2005), and Pss ICMP 3523. Wild-type strains were obtained from the International Collection of Microorganisms from Plants (Landcare Research, Lincoln, New Zealand). All the bacteria were maintained on agarized Luria-Bertani (LB) medium at 27 °C. Inocula were prepared from cultures grown overnight and suspended in 10 mM MgSO_4 to a titre of 10^7 colony-forming units (CFU)/mL. The plant inoculation was performed by cutting one (for *in vitro* plantlets) or all (for seedlings) the leaf tips per plant, with scissors previously dipped in bacterial suspension. Mock inoculation was performed with sterile 10 mM MgSO_4 instead of the bacterial suspension.

PTR-MS analysis

Inoculation with Ea, Pss or 10 mM MgSO_4 (mock infection) was performed on two micropropagated plants, singularly enclosed in 50-mL air-tight vials (about 40 mL of headspace) provided with a pierceable Teflon septum. Temporal changes in the concentrations of specific VOCs, pre-selected by their mass-to-charge ratios (between $m/z = 32$ and

$m/z = 137$) were monitored immediately after inoculation over a period of 4 days. The analytical set-up was described by Spinelli *et al.* (2012). Data taken every 12 h post-inoculation were used for elaboration by principal component analysis (PCA) of variance. A subset including the most informative masses, i.e. those showing a variability over time ($m/z = 33, 41, 43, 45, 47, 57, 59, 61, 63, 65, 69, 87, 95$), was used for PCA, after converting the data to \log_{10} .

GC-MS analysis

The volatiles emitted by cultured bacteria and infected *in vitro* plantlets were analysed by GC-MS. Ea was grown in 50-mL glass tubes containing 10 mL of LB broth. Before analysis, cultures were incubated at 27 °C with moderate shaking (150 rpm) for 24 h. Concerning the VOC emission by plants, for each treatment, three samples consisting of four plantlets enclosed in an air-tight 150-mL glass jar (about 130 mL of headspace) were analysed at 3 days post-inoculation. Jars were closed by a Teflon septum and a butylene stopper. Non-inoculated bacterial medium or axenic plant medium was used for reference. Each sample was pre-incubated for 20 min at 40 °C, and then exposed to a 50 30- μm DVB Carboxen PDMS Stable Flex 2-cm solid phase microextraction (SPME) fibre (Supelco, Bellefonte, PA, USA). After a 40-min exposure, the SPME fibre was desorbed in a Shimadzu GC-MS-QP2010 Plus (Shimadzu, Tokyo, Japan) at 250 °C for 10 min in the split mode. The chromatographic separation of volatile compounds was performed on an RTX-WAX fused-silica capillary column (30 m \times 0.25 mm i.d. \times 0.25 μm) coated with polyethylene glycol (PEG) (Restek, Bellefonte, PA, USA). A three-step heating oven program was set: (1) 45 °C, 10 min; (2) 4 °C min temperature increase to 200 °C; (3) 200 °C, 8 min. Helium was used as the carrier gas at a constant flow rate of 1 mL min. A mass range from 33 to 400 m/z was scanned at a rate of 769 amu s. Mass spectra and linear retention indices (calculated according to the retention times of linear C8–C20 standard alkanes) were used for the identification of volatile compounds, based on the NIST/EPA/NIH Mass Spectral Database (NIST 08, National Institute of Standards and Technology, Gaithersburg, MD, USA) and the ChemSpider information resource (<http://www.chemspider.com>).

To provide an estimation for some of the most relevant compounds identified, known amounts of 2-hexenal, 3-hydroxy-2-butanone, 2,3-butanediol and phenylethyl alcohol were added to 150-mL pots containing plant minimal medium to obtain a standard curve. Sample concentrations were calculated from raw Total Ion Count (TIC) values.

Study of VOC-mediated inter-plant communication

Two different experimental set-ups were designed to study inter-plant communication.

The first set-up used *in vitro*-rooted plantlets, transplanted on half-concentration MS mineral salt medium, in a static environment in which VOCs could accumulate (Fig. 3a). To prevent contamination between infected (VOC emitter) plants and healthy acceptors, an open 150-mL glass vial, containing three Ea-, Pss- or mock-infected VOC-emitting plants, was included in an air-tight 1.5-L glass jar, in which eight healthy plants were exposed for 1 week. Subsequently, the VOC emitters were removed and the receiving plants were infected with the same pathogen as used for the emitters (Ea or Pss) for the assessment of bacterial

endophytic growth and for transcriptional analyses on the host plant (see below). Three biological replicates, each consisting of eight plants from the same jar, were used for each treatment.

The second experimental set-up allowed us to mimic a natural dynamic situation of neighbouring plants (Fig. 3b) without the artificial accumulation of VOCs. Six-month-old potted apple plants were exposed to VOCs from infected plants under an air flow of 9 L/min to provide a complete replacement of the headspace every 3 min. To prevent the influence of VOCs from external sources, each plant canopy was enclosed in an odourless, transparent plastic bag, obtained by the modification of commercial bags for gas sampling (30215-U Supelco, Sigma-Aldrich, St. Louis, MO, USA), and sealed around the stem. The headspace of three infected plants was collected in a buffer glass jar and flowed onto four acceptor plants for 7 days. Four more plants were exposed to mock-inoculated emitters. Millipore filters (pore diameter, 0.2 μm) were placed on the tubing to prevent the accidental spread of bacteria. After exposure, acceptor plants were infected for further experiments.

Assessment of bacterial endophytic growth and migration

The bacterial growth inside the host tissues was measured on *in vitro* plantlets and potted plants, 3 days and 1 week, respectively, after the infection of acceptor plants. The plant samples were surface sterilized by 1-min washing in 70% ethanol and in 1% HClO, followed by two rinses in sterile distilled water. The fresh tissue was then ground in MgSO_4 , and serial 1 : 10 dilutions were obtained from the fresh extract. For each dilution, four 10- μL drops were plated on agarized LB medium. The bacterial population was expressed as the number of CFU per gram of fresh plant tissue.

In addition, bacterial quantification was confirmed by a quantitative polymerase chain reaction (qPCR)-based assay. DNA was extracted from infected plants and processed using primers designed on the plasmid pEA29, as described previously (Salm and Geider, 2004). As a quantification standard, pure *Ea* cultures from 10^2 to 10^8 CFU mL were included in each qPCR assay performed.

Concurrent with the assessment of population size, bacterial migration was assessed on potted plants infected with *Ea* strain 1/79-GFP by microscopic observation of fluorescent bacteria. A Nikon (Tokyo, Japan) C1-S confocal laser scanning microscope, equipped with an argon laser, a 40 \times Nikon PlanApo objective and a BHS (GHS) filter set (excitation, 450–490 nm; emission, 510 nm), was used for image acquisition. A 500- μm graph ocular allowed the measurement of migration. At least four leaves from each acceptor plant were analysed. Leaf veins were enumerated and the presence of *Ea* was screened based on its fluorescence. Where present, the length of the fluorescent trace was measured. The migration rate was calculated as the ratio of infected veins multiplied by the mean value of the relative length of migration inside the veins (Spinelli *et al.*, 2007).

Biometric parameters

The experiment was performed on *in vitro* plantlets on half-concentration MS mineral salt medium in a sealed 1.5-L glass jar containing eight healthy and three inoculated plants in separate compartments. After a 21-day exposure, the infected emitting plantlets were removed from the jar

and the non-inoculated acceptors were used for the determination of the fresh weight/dry weight ratio, total leaf area and daily carbon fixation.

The CO_2 concentration in the 1.5-L jar headspace was measured at the end of the dark period and at the end of the light period using EGM-4 equipment (PP System International, Amesbury, MA, USA). The difference, representing the daily CO_2 fixation, was calculated. The plant samples were subsequently spread on an Epson (Nagano, Tokyo) GT 1200 scanner, and the acquired image was processed by imaging software (GIMP 2.6.6.-GNU Image Manipulation Program, Free Software Foundation, Boston, MA, USA) to estimate the total leaf area. Finally, the fresh and dry weights (after 3 days at 65 °C) were measured.

Expression analysis of SA- and JA-related genes

A quantitative reverse transcription-polymerase chain reaction (qRT-PCR) assay was performed on *in vitro* plantlets after a 1-week exposure to VOCs from infected emitters and at 3 days post-inoculation with *Ea*. Non-exposed and non-inoculated plants were included in this experiment. Three plants per treatment were singularly sampled, frozen in liquid nitrogen and stored at -80 °C until RNA extraction (Schenk *et al.*, 2008). Retrotranscription employed the cDNA First-Strand Synthesis Kit (Life Technologies - Thermo Fisher Scientific, Waltham, MA, USA) according to the manufacturer's protocol. The expression of genes was characterized using a StepOne Plus Real-Time PCR instrument (Applied Biosystems, Foster City, CA, USA) with a SYBR Green-based assay. The primers (listed in Table S1, see Supporting Information) were designed using Beacon Designer v. 8.1 (Premier Biosoft, Palo Alto, CA, USA) and previously tested for specificity. Each reaction was performed in a total volume of 10 μL , containing 5 μL of Power SYBR Green Master Mix 2 \times , 70–100 nm of each primer, 3 μL of a 1 : 6 dilution of cDNA and PCR-grade water. The reactions, performed in triplicate, were incubated for 2 min at 50 °C and 5 min at 95 °C, followed by 40 cycles of 95 °C for 15 s and 60 or 63 °C for 1 min, with data collection at each annealing step. To obtain the gene expression results, raw *Ct* data were analysed by $\Delta\Delta\text{Ct}$ analysis (Livak and Schmittgen, 2001). The actin gene was used as the housekeeping calibrator gene (primer sequences from Paris *et al.*, 2009). Prior to $\Delta\Delta\text{Ct}$ analysis, the primer efficiency was assessed using LingRegPCR software (Ruijter *et al.*, 2009).

Experimental design and statistics

Each experiment was independently repeated at least twice. Statistica 7 (StatSoft Inc., Tulsa, OK, USA) was used for PCA elaboration and statistical analyses. Differences between pre-exposed samples and controls in bacterial population, migration and biometric parameters were analysed with Student's *t*-test. Analysis of variance (ANOVA) and Student–Newman–Keuls' test were applied to gene expression analysis data. Statistically significant differences were assumed for $P \leq 0.05$.

ACKNOWLEDGEMENTS

This work was partially supported by the Q-Detect project, funded by the European Union (EU) 7th Framework Programme (FP7-KBBE-2009-3). Ms A. Laska is acknowledged for technical support. The authors declare no conflicts of interest.

REFERENCES

- An, C.F. and Mou, Z.L. (2011) Salicylic acid and its function in plant immunity. *J. Integr. Plant Biol.* **53**, 412–428.
- Arimura, G., Kost, C. and Boland, W. (2005) Herbivore-induced, indirect plant defences. *Biochim. Biophys. Acta*, **1734**, 91–111.
- de Bernonville, T.D., Gaucher, M., Flors, V., Gaillard, S., Paulin, J.P., Dat, J.F. and Brisset, M.N. (2012) T3SS-dependent differential modulations of the jasmonic acid pathway in susceptible and resistant genotypes of *Malus* spp. challenged with *Erwinia amylovora*. *Plant Sci.* **188–189**, 1–9.
- Bonasera, J.M., Kim, J.F. and Beer, S.V. (2006) PR genes of apple: identification and expression in response to elicitors and inoculation with *Erwinia amylovora*. *BMC Plant Biol.* **6**, 23. doi:10.1186/1471-2229-6-23.
- Bruinsma, M., Posthumus, M.A., Mumm, R., Mueller, M.J., van Loon, J.J.A. and Dicke, M. (2009) Jasmonic acid-induced volatiles of *Brassica oleracea* attract parasitoids: effects of time and dose, and comparison with induction by herbivores. *J. Exp. Bot.* **60**, 2575–2587.
- Cellini, A., Biondi, E., Buriani, G., Farneti, B., Rodriguez Estrada, M.T., Braschi, I., Savioli, S., Blasioli, S., Rocchi, L., Biasioli, F., Costa, G. and Spinelli, F. (2016) Characterization of volatile organic compounds emitted by kiwifruit plants infected with *Pseudomonas syringae* pv. *actinidiae* and their effects on host defences. *Trees*, **30**, 795–806.
- Champigny, M.J. and Cameron, R.K. (2009) Chapter 4 action at a distance. Long-distance signals in induced resistance. *Adv. Bot. Res.* **51**, 123–171.
- DeRoy, S., Thilmony, R., Kwack, Y.B., Nomura, K. and He, S.Y. (2004) A family of conserved bacterial effectors inhibits salicylic acid-mediated basal immunity and promotes disease necrosis in plants. *Proc. Natl. Acad. Sci. USA*, **101**, 9927–9932.
- Gershenzon, J. and Dudareva, N. (2007) The function of terpene natural products in the natural world. *Nat. Chem. Biol.* **3**, 408–414.
- Han, S.H., Lee, S.J., Moon, J.H., Park, K.H., Yang, K.Y., Cho, B.H., Kim, K.Y., Kim, Y.W., Lee, M.C., Anderson, A.J. and Kim, Y.C. (2006) GacS-dependent production of 2R,3R-butanediol by *Pseudomonas chlororaphis* O6 is a major determinant for eliciting systemic resistance against *Erwinia carotovora* but not against *Pseudomonas syringae* pv. *tobaci* in tobacco. *Mol. Plant–Microbe Interact.* **19**, 924–930. doi:10.1094/MPMI-19-9
- Holopainen, J.K. (2004) Multiple functions of inducible plant volatiles. *Trends Plant Sci.* **9**, 529–533.
- Iakimova, E.T., Sobiczewski, P., Michalczyk, L., Wegrzynowicz-Lesiak, E., Mikicinski, A. and Woltering, E.J. (2013) Morphological and biochemical characterization of *Erwinia amylovora*-induced hypersensitive cell death in apple leaves. *Plant Physiol. Biochem.* **63**, 292–305.
- Kai, M., Effmert, U., Berg, G. and Piechulla, B. (2007) Volatiles of bacterial antagonists inhibit mycelial growth of the plant pathogen *Rhizoctonia solani*. *Arch. Microbiol.* **187**, 351–360.
- Kesselmeier, J., Ciccioli, P., Kuhn, U., Stefani, P., Biesenthal, T., Rottenberger, S., Wolf, A., Vitullo, M., Valentini, R., Nobre, A., Kabat, P. and Andreae, M.O. (2002) Volatile organic compound emissions in relation to plant carbon fixation and the terrestrial carbon budget. *Glob. Biogeochem. Cycle*, **16**, 11–26.
- Livak, K.J. and Schmittgen, T.D. (2001) Analysis of relative gene expression data using real-time quantitative PCR and the $2^{-\Delta\Delta CT}$ method. *Methods*, **25**, 402–408.
- Marquez-Villavicencio, M., Weber, B., Witherell, R.A., Willis, D.K. and Charkowski, A.O. (2011) The 3-hydroxy-2-butanone pathway is required for *Pectobacterium carotovorum* pathogenesis. *PLoS One*, **6**, e22974. doi:10.1371/journal.pone.0022974.
- Matsui, K. (2006) Green leaf volatiles: hydroperoxide lyase pathway of oxylipin metabolism. *Curr. Opin. Plant Biol.* **9**, 274–280.
- Murashige, T. and Skoog, F. (1962) A revised medium for rapid growth and bioassays with tobacco tissue cultures. *Physiol. Plant*, **15**, 473–497.
- Naznin, H.N., Kimura, M., Miyazawa, M. and Hyakumachi, M. (2013) Analysis of volatile organic compounds emitted by plant growth-promoting fungus *Phoma* sp. G58-3 for growth promotion effects on tobacco. *Microb. Environ.* **28**, 42–49.
- Paris, R., Cova, V., Pagliarini, G., Tartarini, S., Komjanc, M. and Sansavini, S. (2009) Expression profiling in HcrVf2-transformed apple plants in response to *Venturia inaequalis*. *Tree Genet. Genomes*, **5**, 81–91.
- Ruijter, J.M., Ramakers, C., Hoogaars, W.M., Karlen, Y., Bakker, O., Van den Hoff, M.J. and Moorman, A.F. (2009) Amplification efficiency: linking baseline and bias in the analysis of quantitative PCR data. *Nucleic Acids Res.* **37**, e45. doi:10.1093/nar/gkp045.
- Ryu, C.M., Farag, M.A., Hu, C.H., Reddy, M.S., Wei, H.X., Pare, P.W. and Kloepper, J.W. (2003) Bacterial volatiles promote growth in Arabidopsis. *Proc. Natl. Acad. Sci. USA*, **100**, 4927–4932.
- Ryu, C.M., Farag, M.A., Hu, C.H., Reddy, M.S., Kloepper, J.W. and Pare, P.W. (2004) Bacterial volatiles induce systemic resistance in Arabidopsis. *Plant Physiol.* **134**, 1017–1026.
- Salm, H. and Geider, K. (2004) Real-time PCR for detection and quantification of *Erwinia amylovora*, the causal agent of fireblight. *Plant Pathol.* **53**, 602–610.
- Sarowar, S., Zhao, Y., Soria-Guerra, R.E., Shahjahan, A., Zheng, D., Wang, D. and Korban, S.S. (2011) Expression profiles of differentially regulated genes during the early stages of apple flower infection with *Erwinia amylovora*. *J. Exp. Bot.* **62**, 4851–4861. doi:10.1093/jxb/err147.
- Saxena, R.K., Anand, P., Saran, S., Isar, J. and Agarwal, L. (2010) Microbial production and applications of 1,2-propanediol. *Indian J. Microbiol.* **50**, 2–11.
- Schenk, A., Weingart, H. and Ullrich, M. (2008) Extraction of high-quality bacterial RNA from infected leaf tissue for bacterial in planta gene expression analysis by multiplexed fluorescent Northern hybridization. *Mol. Plant Pathol.* **9**, 227–235.
- Sharkey, T.D., Wiberley, A.E. and Donohue, A.R. (2008) Isoprene emission from plants: why and how. *Ann. Bot.* **101**, 5–18.
- Sparla, F., Rotino, L., Valgimigli, M.C., Pupillo, P. and Trost, P. (2004) Systemic resistance induced by benzothiadiazole in pear inoculated with the agent of fire blight (*Erwinia amylovora*). *Sci. Hortic.* **101**, 269–279.
- Spinelli, F., Ciampolini, F., Cresti, M., Geider, K. and Costa, G. (2005) Influence of stigmatic morphology on flower colonization by *Erwinia amylovora* and *Pantoea agglomerans*. *Eur. J. Plant Pathol.* **113**, 395–405.
- Spinelli, F., Andreotti, C., Sabatini, E., Costa, G., Spada, G., Ponti, I. and Geider, K. (2006) Chemical control of fire blight in pear: application of prohexadione calcium, acibenzolar-S-methyl, and copper preparation *in vitro* and under field conditions. *Acta Hortic.* **704**, 233–237.
- Spinelli, F., Vanneste, J.L., Ciampolini, F., Cresti, M., Rademacher, W., Geider, K. and Costa, G. (2007) Potential and limits of acylcyclohexanediones for the control of blossom blight in apple and pear caused by *Erwinia amylovora*. *Plant Pathol.* **56**, 702–710.
- Spinelli, F., Costa, G., Rondelli, E., Busi, S., Vanneste, J.L., Rodriguez, E.M.T., Savioli, S., Harren, F.J.M., Crespo, E. and Cristescu, S.M. (2011a) Emission of volatiles during the pathogenic interaction between *Erwinia amylovora* and *Malus domestica*. *Acta Hortic.* **896**, 55–63.
- Spinelli, F., Costa, G., Rondelli, E., Busi, S., Vanneste, J.L., Rodriguez, E.M.T., Savioli, S. and Cristescu, S.M. (2011b) Volatile compounds produced by *Erwinia amylovora* and their potential exploitation for bacterial identification. *Acta Hortic.* **896**, 77–84.
- Spinelli, F., Cellini, A., Marchetti, L., Mudigere Nagesh, K. and Piovone, C. (2011c) Emission and function of volatile organic compounds in response to abiotic stress. In: *Abiotic Stress in Plants – Mechanisms and Adaptations* (Venkateswarlu B. and Shanker A.K., eds), pp. 367–394. Rijeka: InTech.
- Spinelli, F., Cellini, A., Vanneste, J.L., Rodriguez-Estrada, M.T., Costa, G., Savioli, S., Harren, F.J.M. and Cristescu, S.M. (2012) Emission of volatile compounds by *Erwinia amylovora*: biological activity *in vitro* and possible exploitation for bacterial identification. *Trees—Struct. Funct.* **26**, 141–152.
- Tamogami, S., Rakwal, R. and Agrawal, G.K. (2008) Interplant communication: airborne methyl jasmonate is essentially converted into JA and JA-Ile activating jasmonate signaling pathway and VOCs emission. *Biochem. Biophys. Res. Commun.* **376**, 723–727.
- Verhage, A., van Wees, S.C. and Pieterse, C.M. (2010) Plant immunity: it's the hormones talking, but what do they say? *Plant Physiol.* **154**, 536–540.
- Wastermack, C. and Kombrink, E. (2010) Jasmonates: structural requirements for lipid-derived signals active in plant stress responses and development. *ACS Chem. Biol.* **5**, 63–77.

SUPPORTING INFORMATION

Additional Supporting Information may be found in the online version of this article at the publisher's website:

Table S1 Primers for expression analysis of salicylic acid (SA)- and jasmonic acid (JA)-related genes.

Fig. S1 Bacterial populations in apple plants, at 7 days (for dynamic flow experiments) or 3 days (for static accumulation experiments) post-inoculation with *Erwinia amylovora* (Ea) or *Pseudomonas syringae* pv. *syringae* (Pss), after previous exposure to plants infected with the same bacterium. Control represents plants exposed to mock-infected neighbours. All of the independent experimental replicates are presented. Mean and

standard error are calculated on the \log_{10} (CFU/g fresh tissue weight) value. Different lower-case letters indicate significant differences ($P \leq 0.05$) between treated (pre-exposed) and control (non-pre-exposed) samples in the same experimental set, according to Student's *t*-test. CFU, colony-forming unit; FW, fresh weight.