

Picturing Indefinite Causal Structure

Aleks Kissinger and Sander Uijlen

Institute for Computing and Information Sciences, Radboud University

{aleks,suijlen}@cs.ru.nl

Following on from the notion of (first-order) causality, which generalises the notion of being trace-preserving from CP-maps to abstract processes, we give a characterization for the most general kind of map which sends causal processes to causal processes. These new, second-order causal processes enable us to treat the input processes as ‘local laboratories’ whose causal ordering needs not be fixed in advance. Using this characterization, we give a fully-diagrammatic proof of a non-trivial theorem: namely that being causality-preserving on separable processes implies being ‘completely’ causality-preserving. That is, causality is preserved even when the ‘local laboratories’ are allowed to have ancilla systems. An immediate consequence is that preserving causality is separable processes is equivalence to preserving causality for strongly non-signalling (a.k.a. localizable) processes.

1 Causality and non-signalling

Throughout this extended abstract, we will work in a self-dual compact closed category \mathcal{C} , that is, a symmetric monoidal category which has for every object a pair of morphisms:

$$\eta_A : I \rightarrow A \otimes A \qquad \varepsilon_A : A \otimes A \rightarrow I$$

which we refer to as *cups* and *caps* respectively, satisfying the following ‘yanking’ identities:

$$(\varepsilon_A \otimes 1_A) \circ (1_A \otimes \eta_A) = 1_A \qquad \gamma_A \circ \eta_A = \eta_A \qquad \varepsilon_A \circ \gamma_A = \varepsilon_A$$

where $\gamma_A : A \otimes A \rightarrow A \otimes A$ is the symmetry natural isomorphism. Furthermore, we will adopt string diagram notation for depicting compositions of morphisms (see e.g. [9]). Using this notion, cups and caps resemble their namesakes:

$$\eta_A := \cup \qquad \varepsilon_A := \cap$$

and hence the equations above become:

$$\begin{array}{c} \cup \\ \cap \end{array} = | \qquad \begin{array}{c} \cup \\ \cap \end{array} = \cup \qquad \begin{array}{c} \cup \\ \cap \end{array} = \cap$$

Note that the monoidal unit I is depicted as empty space. Throughout the paper, we will think of morphisms in this category as physical processes of some kind, hence we adopt ‘process-theoretic’ language. Namely, we refer to objects as *systems* and morphisms as *processes*. Furthermore, we give special names to processes from and to the trivial system:

$$\text{states} := \downarrow \begin{array}{c} \psi \\ \downarrow \end{array} \qquad \text{effects} := \begin{array}{c} \uparrow \\ \pi \\ \uparrow \end{array}$$

In addition to the compact closed structure, we also assume \mathcal{C} has a distinguished effect $d_A : A \rightarrow I$ for every system A called *discarding*. This is pictured as:

$$d_A := \overline{\overline{\top}}$$

and is compatible with \otimes and I as follows:

$$d_{A \otimes B} = \overline{\overline{\top \top}} = \overline{\overline{\top}} \overline{\overline{\top}} = d_A \otimes d_B \quad d_I = \overline{\overline{\square}} = 1_I$$

The utility of the discarding process is it enables us to define *causality*, following [7, 3]:

Definition 1.1. A process $\Psi : A \rightarrow B$ is called *causal* if $d_B \circ \Psi = d_A$, or pictorially:

$$\overline{\overline{\Psi}} = \overline{\overline{\top}}$$

The motto for causal processes is therefore:

If we discard the output of a process, it doesn't matter which process happened.

In the category whose objects are quantum state spaces and whose morphisms are CP-maps, causality corresponds to being a trace-preserving CP-map, i.e. a *quantum channel*.

The utility of causality is that it enables us to use diagrams to represent the causal relationships between processes [7]. For example, if we wish to express that Alice can signal to Bob (but not vice-versa!), we can require that a causal process:

$$\Phi : A_1 \otimes A_2 \rightarrow B_1 \otimes B_2$$

factorises as:

$$\Phi = \Psi_B \circ \Psi_A$$

where Ψ_A and Ψ_B are also causal. Following [6], we see from this factorisation, that it is indeed impossible for Bob to signal Alice. Indeed, if we discard Bob's output (to which Alice does not have access), the whole process disconnects:

$$\overline{\overline{\Phi}} = \overline{\overline{\Psi_B \circ \Psi_A}} = \overline{\overline{\Psi_A}} \overline{\overline{\Psi_B}} = \overline{\overline{\Psi_A}} \overline{\overline{\top}} = \overline{\overline{\Psi_A}} = \Psi'$$

We say such a process is *non-signalling* from B to A , and write $A \preceq B$. Similarly, a process is non-signalling from A to B if it factorises as:

$$\Phi = \Psi_A \circ \Psi_B$$

and we say it is simply *non-signalling* if it admits both factorisations.

A typical example of a non-signalling process is a Bell-type scenario. That is, Alice and Bob share some bipartite state, to which they perform local operations:

$$\Phi = \Psi_A \Psi_B \rho \quad (1)$$

This clearly admits the two factorisations for $A \preceq B$ and $B \preceq A$:

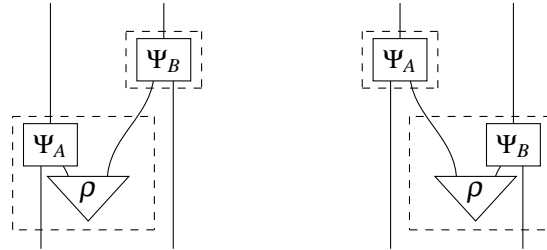

so one might ask if in fact *all* non-signalling processes arise this way. In quantum theory, surprisingly the answer is no.

Definition 1.2. A morphism is called *strongly non-signalling* if it factorises as in equation (1) for some causal morphisms Ψ_A , Ψ_B , and ρ .

It was shown in [1] that there indeed exist quantum channels which are non-signalling but not strongly non-signalling (conditions referred to as ‘causal’ and ‘localizable’ in [1], respectively).

2 Second-order causality

Recently, frameworks have been proposed to discuss quantum correlations which do not necessarily have a fixed causal ordering [8, 4]. Both of these frameworks rely on the notion of a ‘higher-order quantum channel’ [2], i.e. a mapping which sends channels to channels. In this section, we will provide a characterisation of such a map in any compact closed category with discarding.

As is the usual trick in a compact-closed category, we can obtain higher-order maps by first turning first order maps into states by ‘bending up’ the input wire:

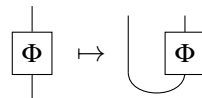

This bending is sometimes called *process-state duality*, which induces a bijection between:

$$\{ \text{processes } \Phi : A \rightarrow B \} \cong \{ \text{states } \check{\Phi} : I \rightarrow A \otimes B \} \quad (2)$$

Hence, we can express a map which sends a process of type $A_1 \rightarrow A_2$ to a process of type $B_1 \rightarrow B_2$ as a map of the form:

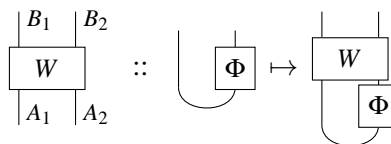

Definition 2.1. A process is called *second-order causal* (SOC) if it sends causal processes (encoded via process-state duality (2)) to causal processes. Diagrammatically, W is SOC if for all Φ :

$$\begin{array}{c} \text{---} \\ \text{---} \\ \boxed{\Phi} \\ | \end{array} = \begin{array}{c} \text{---} \\ \text{---} \\ | \end{array} \implies \begin{array}{c} \text{---} \\ \text{---} \\ \boxed{W} \\ \boxed{\Phi} \\ | \end{array} = \begin{array}{c} \text{---} \\ \text{---} \\ | \end{array} \quad (3)$$

It is often more enlightening to write SOC maps using ‘comb’ notation (cf. [5]):

$$\begin{array}{c} B_1 \quad B_2 \\ | \quad | \\ \boxed{W} \\ | \quad | \\ A_1 \quad A_2 \end{array} \rightsquigarrow \begin{array}{c} B_2 \\ | \\ \boxed{W} \\ | \\ A_2 \\ | \\ A_1 \\ | \\ B_1 \end{array} \quad (4)$$

Then processes are composed from the inside-out, rather than bottom-to-top. Hence, (3) becomes:

$$\begin{array}{c} \text{---} \\ \text{---} \\ \boxed{\Phi} \\ | \end{array} = \begin{array}{c} \text{---} \\ \text{---} \\ | \end{array} \implies \begin{array}{c} \text{---} \\ \text{---} \\ \boxed{W} \\ \boxed{\Phi} \\ | \end{array} = \begin{array}{c} \text{---} \\ \text{---} \\ | \end{array}$$

However, processes with just one ‘hole’ are not that interesting, so we will consider a more interesting kind of second-order causal map, which has two holes:

Definition 2.2. A process:

$$W : (A_1 \otimes A_2) \otimes (B_1 \otimes B_2) \rightarrow C_1 \otimes C_2$$

is called *bipartite second-order causal* (SOC₂) if for all causal Φ_A, Φ_B :

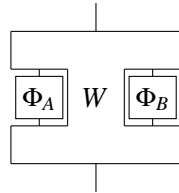

is causal.

Particularly simple examples of SOC₂ maps simply wire Φ_A together with Φ_B in some order:

$$\begin{array}{c} \text{---} \\ \text{---} \\ \text{---} \\ \text{---} \end{array} \begin{array}{c} \text{---} \\ \text{---} \\ \text{---} \\ \text{---} \end{array} \quad (5)$$

However, interestingly, the order that they are wired together is hidden if we treat W as a black box, and it can be shown (see for example [8]) that we can even define SOC_2 maps which don't admit any fixed causal order.

It is natural to ask whether separate notions of *bipartite* (or more generally, n -partite) second-order causal maps is really necessary. We could, after all, define an SOC map as in (4) where $A_1 := X_1 \otimes Y_1$ and $A_2 := X_2 \otimes Y_2$, i.e. of the form:

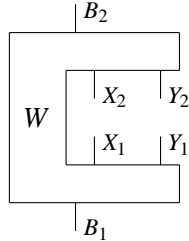

but this is very restrictive since it needs to send any causal map to a causal map, rather than just separable ones. In fact, the simple example of an SOC_2 map which wires two processes together in some fixed order is already not SOC. Suppose for instance that we plug a (non-separable) swap map into the leftmost process in (5):

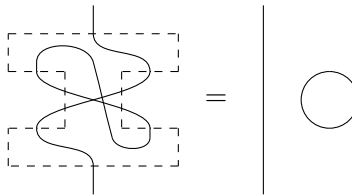

Then we introduce a loop, which for most categories \mathcal{C} (including CP-maps) will immediately kill normalisation, and hence causality.

Definition 2.3. We say a category \mathcal{C} has *enough causal states* if:

$$\left(\forall \rho \text{ causal} \cdot \begin{array}{c} \boxed{\Phi} \\ \downarrow \rho \end{array} = \begin{array}{c} \boxed{\Phi'} \\ \downarrow \rho \end{array} \right) \implies \Phi = \Phi'$$

Since \mathcal{C} is compact closed, we can prove that if \mathcal{C} has enough states, it also has enough *separable* causal states:

$$\left(\forall \rho_1, \dots, \rho_n \text{ causal} \cdot \begin{array}{c} \dots \\ \boxed{\Phi} \\ \downarrow \rho_1 \quad \downarrow \rho_n \end{array} = \begin{array}{c} \dots \\ \boxed{\Phi'} \\ \downarrow \rho_1 \quad \downarrow \rho_n \end{array} \right) \implies \Phi = \Phi'$$

because we can simply apply Definition 2.3 one input at a time, via:

$$\begin{array}{c} \boxed{\Phi} \\ \downarrow \rho \end{array} = \begin{array}{c} \boxed{\Phi'} \\ \downarrow \rho \end{array} \iff \begin{array}{c} \boxed{\Phi} \\ \downarrow \rho \end{array} \cup \text{loop} = \begin{array}{c} \boxed{\Phi'} \\ \downarrow \rho \end{array} \cup \text{loop}$$

3 Second-order causality and non-signalling

Now we are ready to prove the main theorem of this extended abstract and give a simple corollary.

Theorem 3.1. If a process in a category with enough causal states is SOC_2 , then it is ‘completely’ SOC_2 in the sense that, for any causal processes:

$$\Phi_A : A'_1 \otimes A_1 \rightarrow A'_2 \otimes A_2 \qquad \Phi_B : B'_1 \otimes B_1 \rightarrow B'_2 \otimes B_2$$

the process:

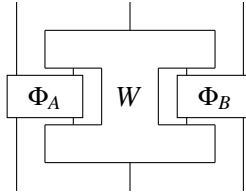

is causal.

Proof. For any causal states ρ_A, ρ_B , the following processes are causal:

(6)

which can be seen just by discarding the respective outputs and applying causality of Φ_A, Φ_B, ρ_A and ρ_B individually. Then, if W is SOC_2 , plugging in the causal maps (6) yields a causal map. Hence, for any ρ_W , we have:

Since the process above agrees with discarding for all ρ_A, ρ_B, ρ_W :

we can conclude, using the fact that \mathcal{C} has enough causal states (and hence enough separable causal states) that:

□

We can now show that SOC_2 processes not only preserve causality for separable processes, but also for strongly non-signalling processes:

Corollary 3.2. If a process W is SOC_2 , then it sends every causal, strongly non-signalling process:

$$\Phi : A_1 \otimes B_1 \rightarrow A_2 \otimes B_2$$

to a causal process.

Proof. If Φ is strongly non-signalling, it factors as in (1). Then:

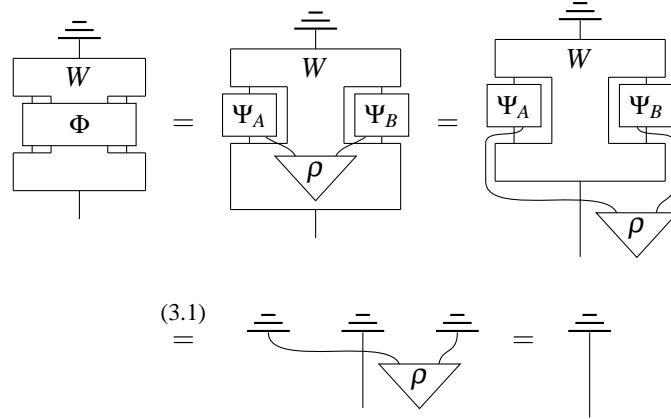

□

In [4] it is shown that preserving causality for product channels is equivalent to preserving causality for all non-signalling channels. This can be shown straight-forwardly in the concrete case of CP-maps using the fact that non-signalling channels always arise as affine combinations of separable channels. One could therefore extend the proof above to work for all non-signalling processes if we replace ρ with a ‘pseudo-state’ given by, e.g.

$$\triangleleft_r := \sum_i r_i |i\rangle\langle i| \otimes |i\rangle\langle i|$$

for (possibly negative) coefficients r_i summing to 1. Then we still have:

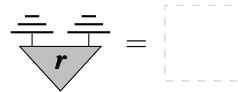

and we can furthermore realise any affine combination of separable CP-maps (hence any non-signalling channel) via:

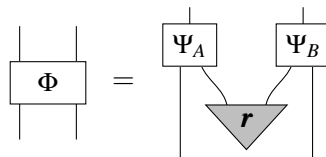

Then the proof of Corollary 3.2 proceeds identically, replacing ρ with r . However, this has the undesirable property that we have to go outside of the category of ‘physically realisable’ processes to get this (non-positive) pseudo-state r . Whether one can give a fully diagrammatic proof without resorting to such tricks is an open question.

4 Acknowledgements

We would like to thank everyone from the 2016 Joint McGill-Oxford Workshop on Causality in Quantum Foundations for fruitful discussions as well as the anonymous reviewers for their useful comments and references. The research leading to these results has received funding from the European Research Council under the European Union's Seventh Framework Programme (FP7/2007-2013) / ERC grant agreement no. 320571

References

- [1] D. Beckman, D. Gottesman, M. A. Nielsen & J. Preskill (2001): *Causal and localizable quantum operations*. *Physical Review A* 64, p. 052309, doi:10.1103/PhysRevA.64.052309. Available at <http://journals.aps.org/prabstract/10.1103/PhysRevA.64.052309>.
- [2] G. Chiribella, G. M. D'Ariano & P. Perinotti (2008): *Transforming quantum operations: quantum supermaps*. *EPL* 83, p. 30004, doi:10.1209/0295-5075/83/30004. Available at <http://iopscience.iop.org/article/10.1209/0295-5075/83/30004/meta>.
- [3] G. Chiribella, G. M. D'Ariano & P. Perinotti (2010): *Probabilistic theories with purification*. *Physical Review A* 81(6), p. 062348, doi:10.1103/PhysRevA.81.062348.
- [4] G. Chiribella, G. M. D'Ariano, P. Perinotti & B. Valiron (2013): *Quantum computations without definite causal structure*. *Physical Review A* 88, p. 022318, doi:10.1103/PhysRevA.88.022318. Available at <http://journals.aps.org/prabstract/10.1103/PhysRevA.88.022318>.
- [5] Giulio Chiribella, Giacomo Mauro D'Ariano & Paolo Perinotti (2009): *Theoretical framework for quantum networks*. *Phys. Rev. A* 80, p. 022339, doi:10.1103/PhysRevA.80.022339. Available at <http://link.aps.org/doi/10.1103/PhysRevA.80.022339>.
- [6] B. Coecke (2014): *Terminality equals non-signalling*, doi:10.4204/EPTCS.172.3.
- [7] B. Coecke & R. Lal (2012): *Causal categories: Relativistically interacting processes*. *Foundations of Physics*, p. to appear, doi:10.1007/s10701-012-9646-8. <https://arxiv.org/abs/1107.6019>.
- [8] O. Oreshkov, F. Costa & C. Brukner (2012): *Quantum correlations with no causal order*. *Nature Communication* 1092(3), doi:10.1038/ncomms2076.
- [9] P. Selinger (2011): *A survey of graphical languages for monoidal categories*. In B. Coecke, editor: *New Structures for Physics*, Lecture Notes in Physics, Springer-Verlag, pp. 275–337, doi:10.1007/978-3-642-12821-9_4. <https://arxiv.org/abs/0908.3347>.